

Overview

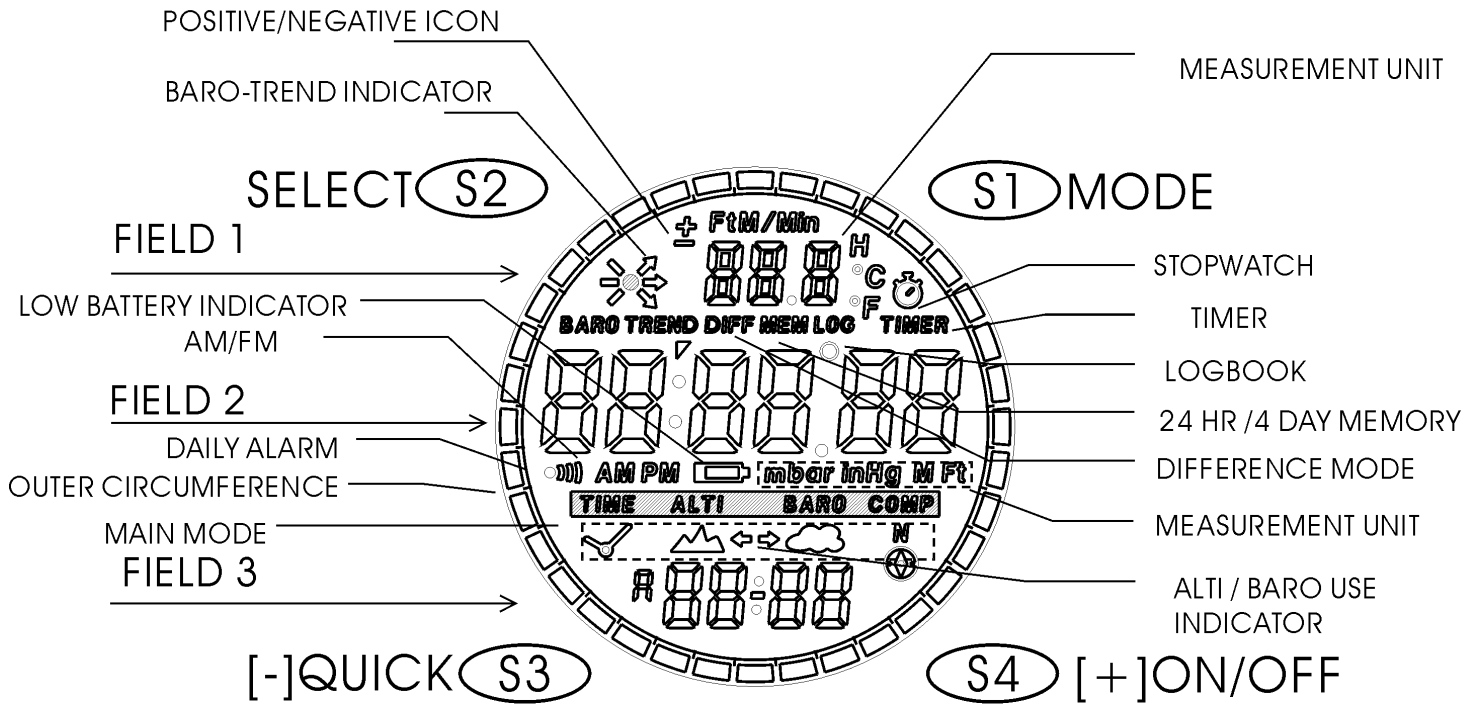

Figure 1 LCD display description

Features

- Hour, minute, second, year, month, day, day of week
- Daily alarm
- Countdown timer
- 24 hour memory in Altimeter
- Current absolute atmospheric
- Compass
- Diagnostics (System Reset)
- Auto calendar
- Dual time
- Altimeter – Barometer Use
- 4 day memory in Barometer
- Sea level pressure
- Electro – luminescent back lighted LCD
- 12/24 hour format display
- Stopwatch
- Difference measurement of Altimeter and Barometer
- Logbook and logbook history
- Temperature display
- Low battery indicator

Care and Maintenance

- Protect your watch from shocks, extreme heat and directly exposure to sunlight.
- Don't try to remove the housing or button of the watch.
- Don't insert any object into the watch.
- Always put the watch in a clear, dry and room temperature environment when the watch is not used.
- Follow the procedure discussed in the manual only.
- Make sure the area around the sensors is free of dust or strong chemical.

Quick Reference Guide

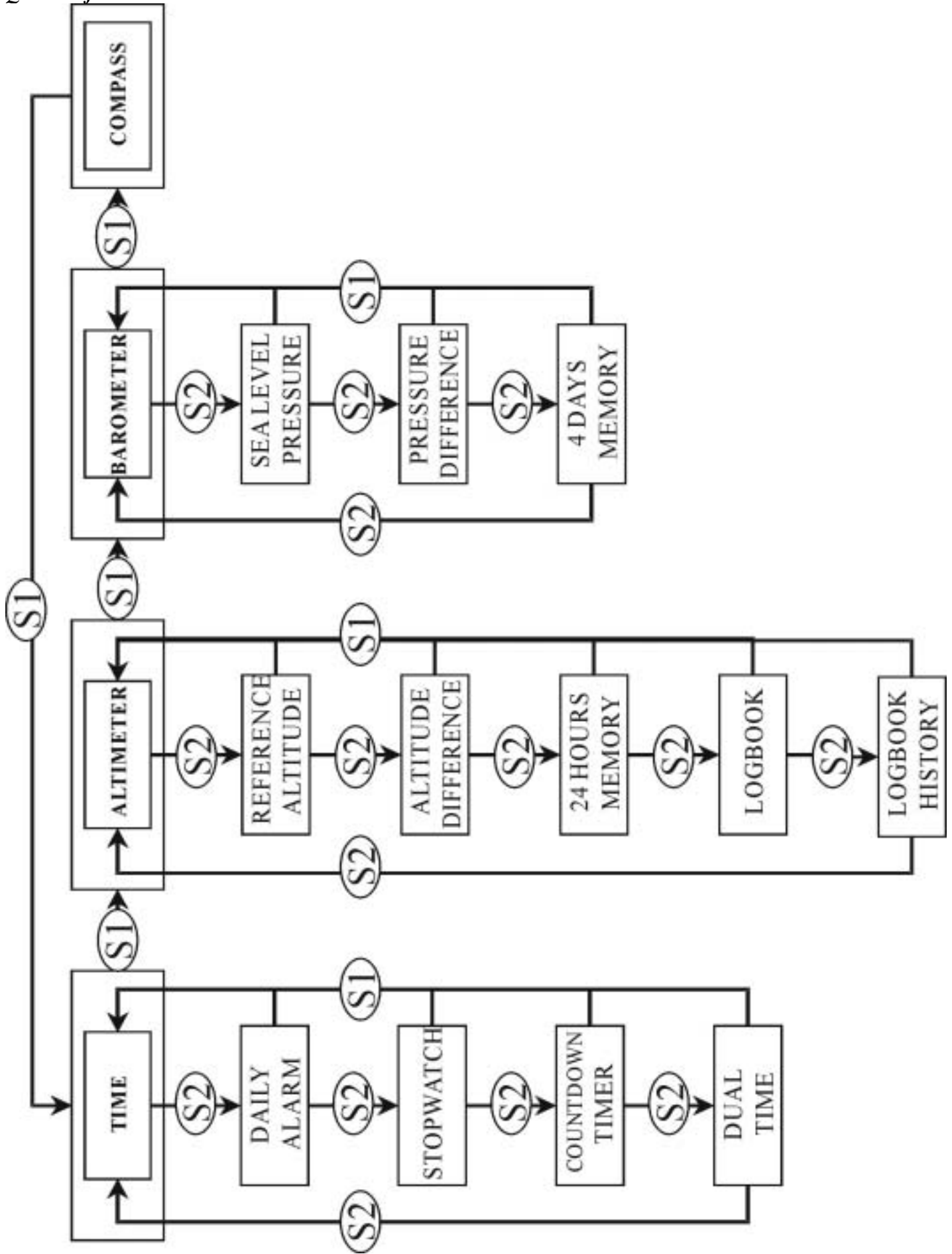



Figure 2 Quick Reference Guide

Time

Time Main Mode

	Path	Press (S1) until the mode indicator points to the “TIME”
	Field 1	Day of week, barometer trend indicator
	Field 2	Hour, Minute, Second
	Field 3	Month, day
	Outer Circumference	Second animation

Adjust

- Hold (S2) for 1 second, the second digit will begin to flash
- Press (S2) to select second → minute → hour → 12/24hour → year → month → day
- Press (S3) or (S4) to set the function
- Press (S1) to accept the setting

Daily Alarm

	Path	Press (S2) ×1 from Time Main Mode
	Field 1	“ON” or “OFF”
	Field 2	Time of a particular alarm
	Field 3	Current time



Adjust

- Press (S3) or (S4) to select the alarm number
- Hold (S2) for 1 second, the “ON” or “OFF” will begin to flash
- Press (S2) to select “ON” or “OFF” → hour → minute
- Press (S3) or (S4) to set the function
- Press (S1) to accept the setting

Note

- “(O)”)”) ” will be displayed when any alarm is enabled.
- The alarm will beep for 30 seconds when the timer reaches. Press any button to disable beeping.
- Two “beep” will sound when the alarm is enabled. One “beep” will sound when any alarm is disabled.

Stopwatch

	Path	Press (S2) ×2 from Time Main Mode
	Field 1	Hour and stopwatch icon 
	Field 2	Minutes, second and 1/100 second
	Field 3	Current time

Setup

- Press (S4) to start
- Press (S3) to split
- Press (S4) to stop
- Press (S3) to reset the stopwatch

Note

- “” will begin to flash when user leave the mode while it is functioning.

Countdown Timer

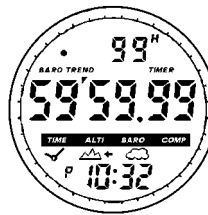
	Path	Press (S2) ×3 from Time Main Mode
	Field 1	Hour and “TIMER”
	Field 2	Minutes, second and 1/100 second
	Field 3	Current time

Adjust

- Hold (S2) for 1 second, second will begin to flash
- Press (S2) to select second → minute → hour
- Press (S3) or (S4) to set
- Press (S1) to accept the setting
- Press (S4) to start → stop
- Press (S3) to reset

Notes

- The timer will beep for 30 seconds when the timer reaches zero. Press any button to disable beeping.
- “TIMER” will begin to flash when user leave the mode while it is functioning

Dual Time

	Path	Press (S2) ×4 from Time Main Mode
	Field 1	“dUA”
	Field 2	Current time
	Field 3	Dual time

Adjust

- Hold (S2) for 1 second, the hour digit will begin to flash
- Press (S2) to select hour → minute
- Press (S3) or (S4) to set the function
- Press (S1) to accept the setting

Altimeter

Altimeter Main Mode

	Path	Press (S1) until the mode indicator points to “ALTP”
	Field 1	Vertical ascent and decent rate, barometer trend indicator
	Field 2	Current altitude
	Field 3	Current time
	Outer Circumference	Altitude Animation. A complete circle represents 1000 meter or 1000ft

Notes

- The watch will be back to Time Main Mode after 12 hours.

Altimeter – Barometer Use Selection

- When Altimeter Use is selected, all pressure changes are interpreted as altitude change.
- When Barometer Use is selected, all pressure changes are interpreted as weather change.

	Path	Press (S2) ×1 from Altitude Main Mode
	Field 1	Display the “REF”
	Field 2	Current altitude
	Field 3	“USE”
	Outer Circumference	Altitude animation. A complete circle represents 1000 meter or 1000ft

Setup

- Altimeter – Barometer Use Selection
 - Press (S3) or (S4) to switch the direction of arrow (“Altimeter Use” or “Barometer Use”)
 - Press (S1) to accept the setting

- Reference Altitude Adjustment
Hold (S2) for 1 second → Current altitude on field 2 will begin to flash. → Press (S3) or (S4) to set the function → Press (S1) to accept the setting

Note

- Setting of the reference altitude of a current location will also change the sea level pressure. If the user is at a known altitude, adjustment of the reference altitude to this correct altitude will give the present sea level atmospheric pressure.

Altimeter Difference Measurement

- Enable user to measure the absolute altitude difference between the start and stop time.

	Path	Press (S2)×2 from Altitude Main Mode
	Field 1	Vertical ascent or decent rate and “DIFF”
	Field 2	Current altitude
	Field 3	Running time
	Outer Circumference	Altitude animation. A complete circle represents 1000 meter or 1000ft

Setup

- Hold (S2) for 1 second, “SET” will display on Field 1 and a zero value will begin to flash on Field 2
- Press (S3) or (S4) to select a non-flashing altitude (the previous altitude difference record) to resume the previous difference measurement. User selects the flashing zero will start a new difference measurement. For a new difference measurement, the time will start running automatically.
- Press (S1) to accept the setting

Stop or Resume Difference Measurement

- In the Altimeter Difference Measurement mode → Press (S4) to stop or resume the measurement

Notes

- Altimeter different measurement cannot start when Barometer Use is selected.
- “:” in field 3 will begin to flash to indicate the difference measurement mode is in operation.
- “DIFF” will begin to flash when user leave the mode while it is functioning
- The watch will return to Time Main Mode after 12 hours.
- Running time displays up to 99 hours and 59 minutes. Afterwards, (--:--) appears in Field 3.

24 hour Memory

- This is the altitude record for the last 24 hours

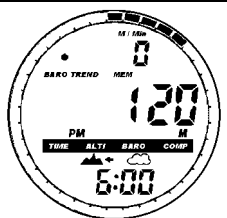
	Path	Press (S2)×3 from Altitude Main Mode
	Field 1	Vertical ascent or decent rate and “MEM”
	Field 2	Current altitude
	Field 3	Flashing hour
	Outer Circumference	Altitude animation. A complete circle represents 1000 meter or 1000ft

- Viewing Information
Press (S3) or (S4) to scroll forward and backward to view the corresponding altitude, ascent and decent rate of the particular hour

Notes

- Either select Altimeter Use or Barometer Use to record the on-the-hour information for the last 24-hours.
- The watch will return to Time Main Mode after 10 minutes.

Logbook

- It records the average vertical ascent and descent rate, total vertical distance travelled, elapsed time, date, lap number and log number.
- The logbook has five displays. The display automatically displays the first frame for 7 seconds, and the rest for 4-seconds.

- View Logbook
Press (S2)×4 from Altitude Main Mode
Press (S3) or (S4) to scroll the records

○ Operation of Logbook

Start logbook by quickly pressing (S4) ×2 in the Altimeter Main Mode → “LOG” will begin to flash, a new logbook will start immediately

Stop the current logbook by quickly pressing (S4) ×2 in the Altimeter Main Mode → “LOG” will disappear

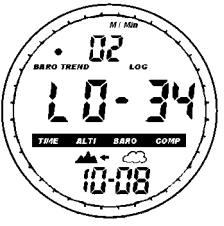
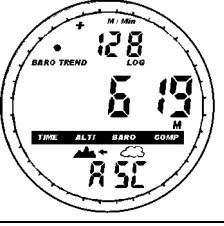
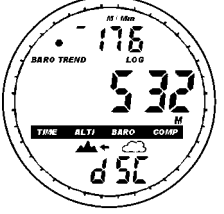
	Display 1	Current log information
	Field 1	Year and “LOG”
	Field 2	“LO” with current logbook number flashing
	Field 3	Month and day of the particular logbook number
	Display 2	Ascent information for the current logbook
	Field 1	Average ascent rate during the event and “LOG”
	Field 2	Total vertical ascent
	Field 3	“ASC”
	Display 3	Descent information for the current logbook
	Field 1	Average descent rate during the event and “LOG”
	Field 2	Total vertical descent
	Field 3	“dSC”

Note

- The maximum ascent and descent that can be shown in one logbook is 9999999 m/ft.

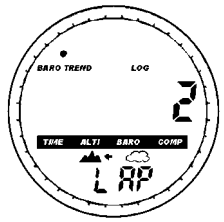
	Display 4	Number of laps
	Field 1	“LOG”
	Field 2	Total number of ascent and descent
	Field 3	“LAP”

Note

- A lap is a vertical movement including either ascent or descent equal to 50m (150 ft).

	Display 5	Time duration of recording information
	Field 1	“LOG”
	Field 2	Total time of log
	Field 3	“dUr”

Notes

- The memory capacity is 99 logs, maximum 20 hours duration for each. After the log number 99 is being used, the following logbook will replace the memory of the first record.
- “LOG” will begin to flash when user leave the mode while it is functioning.
- The watch will return to Time Main Mode after 10 minutes
- Logbook will not function when Barometer Use is selected.

Clearing logbook

- Press (S2) ×4 from Altimeter Main Mode. → Hold (S2) for 1 second, “CLR” and “LOG” will display on Field 1 and “LOG-XX” will display on Field 2. “NO” will flash on Field 3
- Press (S2) to select the current logbook or entire logbook
- Press (S3) or (S4) to select “YES” or “NO”
- Press (S1) to accept the setting

Logbook History

- The logbook history shows a summation of all logs recorded, such as total vertical distance, highest altitude, the best ascent and decent rate, date.

Setup

- Press (S2)×5 from the Altimeter Main Mode

There are totally four displays, they are:

	Display 1	Current logbook history
	Field 1	Year of the last cleared logbook history and “LOG”
	Field 2	“HIS”
	Field 3	Month and day of the last cleared logbook

- Press (S3) or (S4) to scroll the records

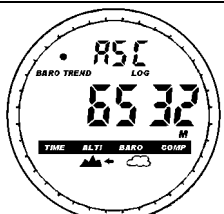
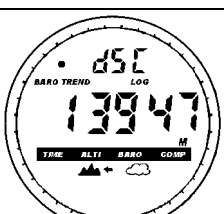
	Display 2	The highest Record
	Field 1	Flashing “HF” and “LOG”
	Field 2	Highest altitude recorded since the last date cleared
	Field 3	Year and date interchange for 4 secs
	Display 3	Accumulative ascent Record
	Field 1	Flashing “ASC” and “LOG”
	Field 2	Total accumulative vertical ascent since the last reset
	Field 3	Blank
	Display 4	Accumulative descent record
	Field 1	Flashing “dSC” and “LOG”
	Field 2	Total accumulative vertical descent since the last reset
	Field 3	Blank

- Press (S1) or (S2) to exit this activity and back to Altimeter Main Mode

Notes

- The watch will return to main mode after 10 minutes
- Logbook history records remain unchanged when Barometer Use is selected

Clearing the logbook history

- Hold (S2) for 1 second, “CLR” and “LOG” will display on Field 1 → “HIS” will display on Field 2 → “NO” will begin to flash on Field 3
- Press (S3) or (S4) select “YES “ or “NO”
- Press (S1) button to accept the setting

Remarks

- Measurement on the rate of vertical movement and vertical altitude in 1-second intervals for first 2 seconds. A flashing zero will be shown in the first 2 seconds.
- Weighted Current Rate is used to determine the frequency of measurement of altimeter. Micro processor in the watch uses the most recent 3 current rates, which are the ascent rate or descent rate taken by the altimeter sensor, to calculate the measurement frequency. 1 measurement per 1, 2, 5 or 10 secs is used depending on the results of the calculation.

Barometer

Barometer Main Mode

	Path	Press (S1) until the mode indicator is directly below “BARO”
	Field 1	Current temperature, barometer trend indicator
	Field 2	Sea level pressure
	Field 3	Current time or current absolute atmospheric pressure
	Outer Circumference	Pressure animation. One complete circle shows the atmospheric pressure over 100 mbar or 1 inHg

- Press (S4) to select current time or current absolute atmosphere pressure on field 3

Notes

- The absolute atmospheric pressure is the actual pressure in any location at any given time.
- When Altimeter Use is selected, only the current atmosphere pressure reading will change.

Barometer Trend Indicator

- Barometric trend is comprised of two lines forming an arrow. The left line represents the trend from –6 to –3 hours and the right arrow represents the trend from –3 to the present time. They can indicate 9 different patterns in the barometric trend.

		Situation last 3 hours		
		Drop heavily	Remaining stable	Rise heavily
Situation 3-6 hours ago	Drop heavily			
	Remaining stable			
	Rise heavily			

Notes

- Rise or drop heavily means drop or raise more than 2 mbar within 3 hours.
- When the Altimeter Use is selected, the trend indicator is not shown, except the 4-day memory mode.

Altimeter – Barometer Use Selection

- Select the Altimeter Use or Barometer Use.
- Adjust the sea level pressure.

	Path	Press (S2)×1 from the Barometer Main Mode
	Field 1	“SEA”
	Field 2	Sea level pressure
	Field 3	“USE”
	Outer Circumference	Pressure animation. One complete circle shows the atmospheric pressure over 100 mbar or 1 inHg

Setup

- Altimeter – Barometer Use Selection
 - Press (S3) or (S4) to switch the direction of arrow (“Altimeter Use” or “Barometer Use”)
 - Press (S1) to accept the setting
- Sea Level Pressure adjust
 - Hold (S2) for 1 second → Sea level pressure on field 2 will begin to flash. → Press (S3) or (S4) to set the sea level pressure. → Press (S1) to accept the setting

Notes

- Information on the current sea level pressure can be obtained through newspaper, local news and radio weather reports, local airport or the Internet.

- When Altimeter is selected, Barometer Difference Measurement cannot be started.

Pressure Difference Measurement

- It measures the absolute difference in barometric pressure within a start and stop time.

	Path	Press (S2)×2 from the Barometer Main Mode
	Field 1	Change in temperature, barometer trend indicator, “DIFF”
	Field 2	Change in sea level pressure
	Field 3	Duration time
	Outer Circumference	Pressure animation. One complete circle shows the atmospheric pressure over 100 mbar or 1 inHg

Setup

- Hold (S2) for 1 second, “SET” will display on Field 1 and a zero value will begin to flash on Field 2
- Press (S3) or (S4) to select a non-flashing pressure difference (the previous pressure difference record) to resume the previous difference measurement or select the flashing zero to start a new difference measurement. For a new difference measurement the time will start running automatically.
- Press (S1) to accept the setting
- Press (S4) to stop or resume the measurement

Notes

- Every time this mode is entered, the reading will start with flashing zero.
- “DIFF” will begin to flash when user leave the mode while it is functioning
- When Altimeter Use is selected, all information will not change in this mode.
- The watch will return to Time Main Mode after 12 hours.

4 day Memory Mode

- The changes in pressure in the last 4-days help the user to forecast the weather condition.

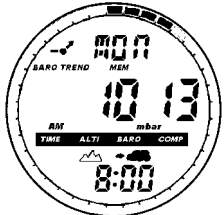
	Path	Press (S2)×3 from the Barometer Main Mode
	Field 1	Day of week, barometric trend indicator and “MEM”
	Field 2	Sea level pressure
	Field 3	Particular flashing hour
	Outer Circumference	Pressure animation. One complete circle shows the atmospheric pressure over 100 mbar or 1 inHg

- Press (S3) or (S4) to view records

Notes

- The latest 6 records are taken in 1-hour intervals. Other records are taken in 6-hour intervals
- Barometer trend indicator only appears in this mode when Altimeter Use is selected.
- The watch will return to main mode after 10 minute.

Calibration of Absolute Pressure

- User can calibrate the absolute atmosphere pressure.

Adjust

- In the Barometer Main Mode, hold (S2) for 1 second, the absolute atmosphere pressure value will begin to flash on field 2
- Press (S3) or (S4) to set,
- Press (S1) to accept the setting

Important notes

- The absolute pressure is calibrated by factory, it is not recommended for the user to set the value in daily use.

- When there is a physical characteristic shift of sensor due to aging, or when the watch has been left unused for more than one year, calibrating the absolute pressure is recommended.
- To find out an accurate pressure value, use a professional barometer to calibrate the absolute pressure.
- User can also adjust the watch at seaside after getting an accurate sea level value from local weather observatory.

Remarks

- Pressure and temperature changes are measured in intervals of 10 seconds.
- Barometric values are measured at 1-hour intervals to estimate the barometric trend.
- Temperature range: -10°C to 60°C (14°F to 140°F). “LL” will be displayed when the temperature is lower than -10°C and “HH” will be displayed when the temperature is higher than 60°C .

Compass

Compass Mode

- Direction showing in the current location

	Path	Press (S1) until the mode indicator is directly below “COMP”
	Field 1	Cardinal point abbreviation
	Field 2	Bearing in degree
	Field 3	Current time
	Outer Circumference	Graphically displays the North and South Arrows, where 1 – segment lit is the North

Use of Compass

- Compass displays actively for 30 second → goes into sleep mode and “- --°” will show on field 2 → Press either (S3) or (S4) to reactive the compass

Notes

- Calibration of compass is required for the first time or after battery replacement.

Calibration of Compass

- Compass should be calibrated when it is subjected to close proximity of magnetic sources, extreme cold weather, every time the battery is replaced or suspected that any environmental conditions have affected the compass reading.

Adjust

- Hold (S2) for 1 second, → “CMP” will be displayed on field 1, “PUSH-” will begin to flash on field 2 and “CAL” will display on field 3.
- Press (S3) to start the calibration → “360°” will be displayed on field 2 and the outer circumference displays all segment lit
- Hold the watch on observer level and slowly rotate it in either clockwise or anti – clockwise direction, for 1 complete turn. → “DONE” will be displayed on field 2 when all segments disappear → Press (S1) to accept the setting

Note

- The watch will return to Time Main Mode after 30 minutes.

Other Functions

Measurement Units

- There are two unit groups of measurement, They are metric such as (M, mbar, °C , M/Min) and imperial such as (Ft, inHg, °F , Ft/Min)

Setup

- Press (S1) until the mode indicator is directly below “*TIME*” → Hold (S1) and (S2) for 1 second → Field 1 will firstly display “*SET*” for 2 second, and then display “*UNT*” and the preset units → Hold (S2) for 1 second, “*M*” or “*Ft*” located on field 2 will begin to flash
- Press (S2) to select “*M*” or “*Ft*” → “*mbar*” or “*inHg*” → “*°C*” or “*°F*” → “*M/Min*” or “*Ft/Min*”
- Press (S3) or (S4) to set the function
- Press (S1) to accept the setting

Backlight

- Hold (S1) for 1 second, → backlight will turn on for 5 seconds → Press any key when the backlight is on will keep the light for another 5 seconds

Note

- To ensure sufficient electric current for pressure sensor, the EL backlight is disabled automatically during sensing and it will turn on for 5 seconds after finishing the sensing.

Low Battery Indicator

- The low battery indicator will be turned on when the battery voltage level drops below 2.5V in eight out of ten times.

Fast Button Features

- In any mode, press (S3) will go to the fast button feature immediately. After 12 seconds, it will return to the original mode that you were viewing before.
- The Fast button feature allows the user to check the cumulative vertical ascent or descent, the number of laps of current logbook or the last logbook. These three displays will show sequentially with a 4 second interval.

Key tone

- Press any button will have a “beep” sound.

System Reset and diagnostics

- After resetting the watch, the system will be reinstalled. All memories such as logbook, logbook history, difference measurements in altimeter and barometer, 24-hour memory and 4-day memory, will be cleared.
- The date and time format will be at 12:00am, 1 Jan 2002, 12 hour format and unit is metric.
- The diagnostic mode is entered upon system reset; all the LCD segments will be lit and the buzzer will be turned on for 3 seconds.

Measurement Specification

Sensor Measurement

Mode	Frequency of measurement
4 day memory mode	1 per hour
24 hour memory mode	1 per hour
Altimeter main mode	1 per sec for the first 2 secs, thereafter is depended on the Weighted Current Rate.
Barometer main mode	1 per 10 secs
Compass main mode	Deactivate after 30 secs
Difference measurement in Altimeter mode	1 per 10 secs

Note

- Please refer to the remark of Altimeter for the details of Weighted Current Rate.

Ranges and Resolution

Range	
Altimeter	-499m to 9001m or -1600ft to 29500ft
Barometer	299mbar to 1101mbar or 8.9inHg to 32.40inHg
Calendar	1 Jan, 2002 to 31 Dec, 2099
Sea Level Pressure	299mbar to 1101mbar or 8.9inHg to 32.40inHg
Temperature	-10°C to 60°C or 14°F to 140°F .
Resolution	
Altimeter	1m or 3 ft
Barometer	1mbar or 0.05inHg
Compass	1° for bearing and ± 3° for North – South Direction
Temperature	0.1 °C or 0.1 °F

Unit Conversion

- 1 meter = 3.28 ft
- 1 mbar = 0.0295 inHg

Battery Replacement

- It is recommended to replace the battery when the low battery warning icon is on.
- Cell Type: CR 2032
- The expected battery life is approximately 12 to 24 months, depending on usage.

Procedure to replace the battery

1. Insert a coin into the slot on the battery compartment cover on the watch back.
2. Turn the coin anti-clockwise until the dot on the cover is aligned with 'open' on the back.
3. Remove the battery compartment cover. Make sure the o-ring and the slot are clean and dry. Take care not to remove the o-ring.
4. Remove the battery carefully. Take care not to bend the side contact.
5. Put a new battery into the battery compartment with the positive side facing up.
6. With the o-ring in the correct position, replace the battery compartment cover and turn it with the coin clockwise until the dot is aligned with 'close'.

Notes

1. Extreme low temperatures may cause the low battery warning icon to turn on. This does not require battery replacement.
2. Frequent use of the electroluminescent backlight reduces battery life.
3. Battery replacement should be performed with extreme care so as to ensure the watch is still waterproof.

Initial Setup

- When the watch is used the first time or after battery replacement, it is recommended to set the following functions:

1. Unit setting (Default setting is metric unit). For imperial system, please refer to *Measurement Unit*.
2. Time setting. Please refer to *Time Main Mode*.
3. Compass calibration. Please refer to *Calibration of Compass*.

Notes

- When no button is pressed for 30 seconds or press (S1), the display will automatically exit any setup.
- In all sub modes, press (S1) to exit immediately to its main mode.

For more details, please visit

www.CEI-ULTRAK.com

F18BK
Printed in China